



CHILD SAFE  
APPROVED

## PVC Venetian Blind Installation Instructions

NOTE: These blinds are not advised for installation in conservatories or rooms where temperature may exceed 45°C

### TOOLS REQUIRED

To Install

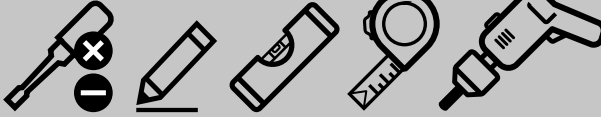

To Adjust  
Drop



To Adjust  
Width



### ACCESSORIES ENCLOSED

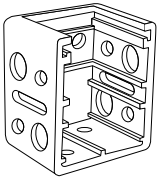

2x  
End Brackets

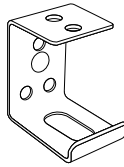

0-3x  
Support  
Brackets



2x  
Face  
Plates

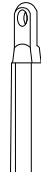

1x  
Wand

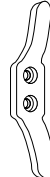

1x  
Cleat

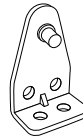

2x  
Retention  
Plate

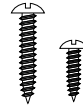

6-14x  
Screws

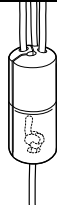

1x  
Cord Break\*  
*(See note below)*

\*PLEASE NOTE: Only Blinds fitted with more than 2 pull strings (width 120cm and above) will have an additional Cord Break attached.

### HOW TO INSTALL

**NB: Blind headrails shall not be installed less than 1.5m from the floor.**

#### 1 Fix brackets

Measure and mark bracket position. Drill holes in the wall substrate and plug if required, then fix the 2 x brackets into place with the screws provided.

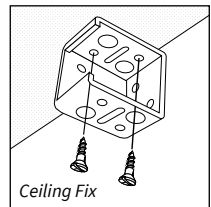
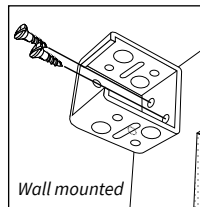
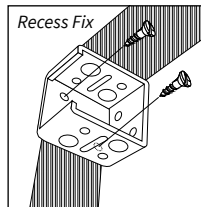

#### 2 Fix intermediary support brackets

For blind width sizes over 75cm you then need to fix support brackets. Ensure these brackets are positioned to line-up exactly with the slots on the underside of the head rail.

**NOTE:** The support bracket closest to the pull cord end must be installed. **This is essential.**

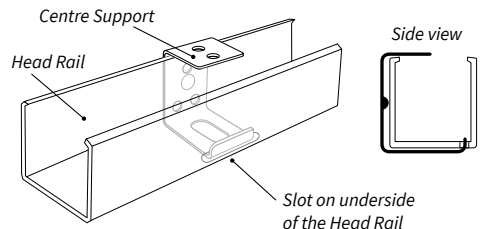

### 3 Insert face plates

Insert blind head rail into the end brackets, then slide into position the bracket face plates into the front of each bracket.

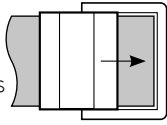

### 4 Fix wand

Connect the wand to the tilt control hook, which is positioned towards the left hand side of the blind.

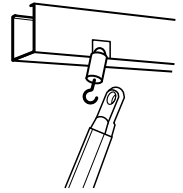

### 5 Securing blind to bottom of window

If you want to secure the blind to the bottom of the window (optional), the hole on the end of the bottom weight bar fits into the retention plate (provided) at the base of the window. Screw the plate securely to the window frame and then clip into the bottom weight bar.

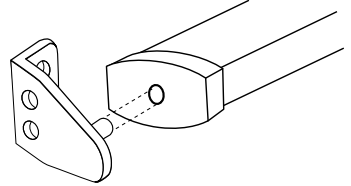

### 6 To shorten the blind drop height

**NOTE:** Before fitting you can custom fit the blind to the correct height by follow the instructions below.

**6.1** When the blind is fully lowered there should be no slats over lapping at the bottom of the blind. If over lapping occurs you can remove slats to allow a custom fit.

**6.2** Hold the blind at the desired location and allow it to fully lower. In the open position the slats should be approximately 2cm apart.

**NOTE:** A good rule of thumb is to remove 8 slats for every 150mm (6") you wish to shorten the blind by.

**6.3** Lay blind on a flat surface and remove the caps on the bottom weight bar. The caps cover the lift cords [fig. 1].

**6.4** Cut lift cord 2cm above cap and remove. Pull the lift cord from the bottom weight bar to allow it to slide out of the ladder rung [fig. 2].

**6.5** Count the number of slats you wish to remove. Pull the lift cord from these slats to allow them to slide out of the ladder rung and remove the required number of slats [fig. 3].

**6.6** Remember to allow for the bottom weight bar to be reinserted, then thread the lift cord back through the cap holes.

**6.7** Knot lift cord directly beneath the bottom weight bar and cut off excess cord [fig. 4]. Allow one extra rung and cut off excess ladder, now tuck remaining ladder into the bottom weight bar cap holes. Then replace the caps [fig. 5].

**6.8** After blind is shortened you may wish to adjust the pull cord length. Remove the plastic cover over the knot and cut off excess cord and then re-knot.

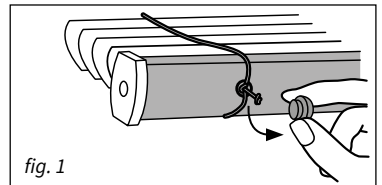

fig. 1

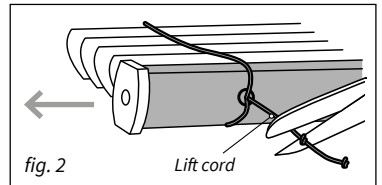

fig. 2

Lift cord

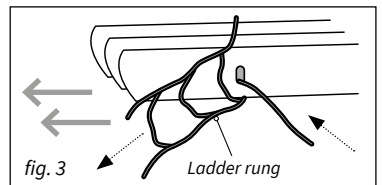

fig. 3

Ladder rung

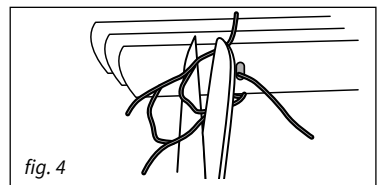

fig. 4

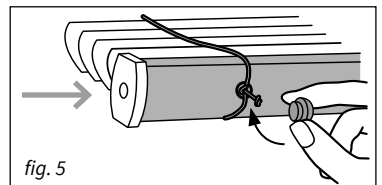

fig. 5

## 7 To operate the blind

**To raise blind:** Move cord to the left then pulling it down gently until cord lock releases. Pull cord down towards the left until blind reaches desired position [fig. 6], then move cord to the right and release [fig. 7]. The blind will lock automatically.

**To lower blind:** Move cord to the left then pull it down gently until cord lock releases. Allow blind to descend until it reaches the desired position. Move cord to the right and release, the blind will lock in position automatically.

**WARNING: Do not pull the cord downward directly – this may break the blind!** [fig. 8]

**To tilt blind slats:** Rotate 'wand' on left side of blind either clockwise or anti-clockwise to attain desired slat positions [fig. 9].

**IMPORTANT:** Always adjust the tilt of the blind slats to horizontal before raising or lowering the blind – this increases the life of the blind.

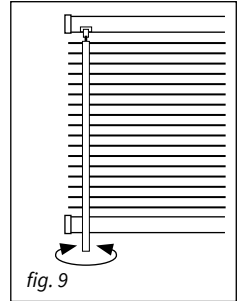
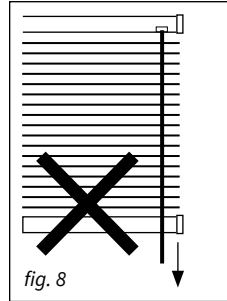
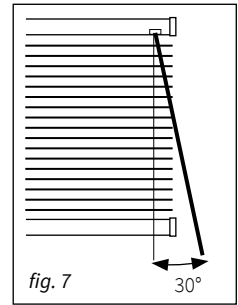
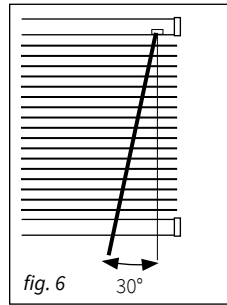

# CHILD SAFETY IS MANDATORY! ALL CHAINS AND LOOPS MUST BE SECURED

For more information please visit [www.rca-uk.com/childsafety](http://www.rca-uk.com/childsafety)



CHILD SAFETY  
APPROVED

## 8 Position safety cord-stops

**8.1** Install the blind as detailed overleaf, making sure the head rail is securely fastened. Lower blind to maximum desired length and lock in to place.

**8.2** Measure the distance from head rail to cord-stops. If cord-stops are 25–50mm below the head rail, no further adjustment is needed and your blinds are ready to use.

**8.3** If cord-stops **ARE NOT** 25–50mm below the head rail, loosen (but do not untie) the knot surrounding the cord-stop [fig. 10].

**8.4** Push both the cord-stop and the loosened knot toward the head rail until the cord-stop is 25–50mm below the head rail [fig. 11].

**8.5** Hold cord-stop in place and pull firmly on pull cord to re-tighten knot.

**8.6** Repeat 8.3 through 8.5 for each cord-stop.

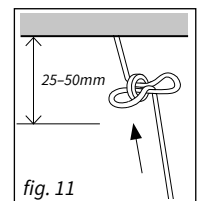
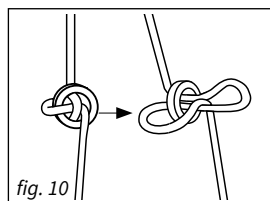
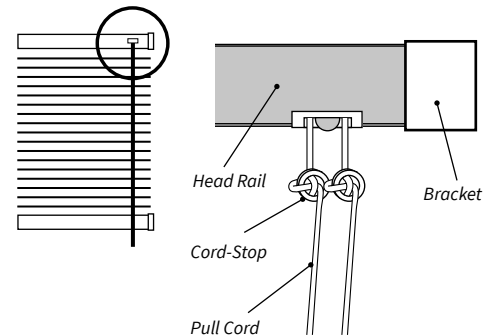

## 9 Install cord cleat hook accumulation system

Install the cleat hook accumulation system as close to the headrail as possible and, in all cases, not less than 1.5m from the floor.

Hold the cord cleat up parallel with the window frame. Mark dots through the holes. Drill pilot holes and fix the cleat with screws provided.

Wind cord in a figure-of-eight motion around the cleat to keep cords out of reach. Cords should be fully wound around the cleat hook accumulation system so that no part of the cord is left within reach of children.

COMPLIANT WITH BS EN 13120: 2009+A1:2014 / 16433 / 16434.

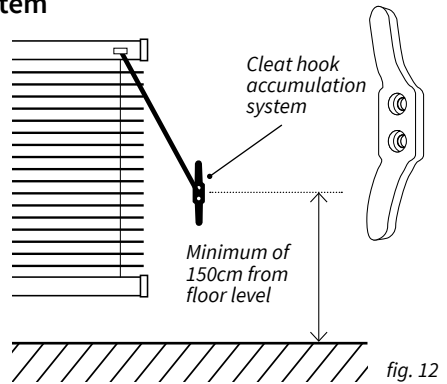

## 10 Cord Break Child Safety feature

Blinds fitted with more than 2 pull strings will have an additional Cord Break attached. The Cord Break allows normal operation of the blind [fig. 13], but will break if the cords are separated apart [fig. 14].

Do not tie any knots in the strings above the Cord Break as it will defeat this important Child Safety feature.

**NOTE:** Should the Cord Break safety feature separate, simply reinsert the loose cord(s) and clip the unit back together.

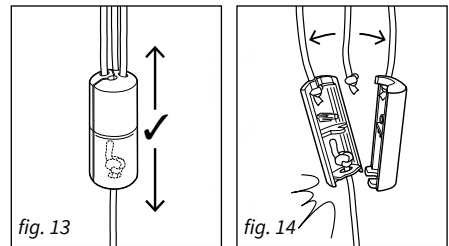

# WARNING

**Young Children can be strangled by loops in pull cords, chains, tapes and inner cords that operate the product.**

To avoid strangulation and entanglement, keep cords out of the reach of young children. Cords may become wrapped around a child's neck. Move beds, cots and furniture away from window covering cords. Do not tie cords together. Make sure cords do not twist and create a loop.

**NOTE: Fitting guidelines state that the safety device should keep the cords taut and should not be fitted less than 1.5m from floor level.**

Go to [www.makeitsafe.org.uk](http://www.makeitsafe.org.uk) for further details.



**make it safe**

## 11 To trim blind width

Your blind can be trimmed by up to 80mm each side (160mm max total). To trim the blind to size:

**11.1** Measure the overall width of the outer distance of the mounted end support brackets and deduct 5mm to get the desired finished blind width.

**11.2** Calculate the amount that needs to be cut off the blind headrail.

**11.3** Divide this measurement by two, then mark and cut this amount equally off each side of headrail using a hacksaw.

**11.4** Remove the end-caps on the bottom weight bar and shorten this in the same manner, then replace the endcaps.

**11.5** Then using a Renaissance Venetian Blind Slat Cutter, trim the same measurement off end of each slat.

**Blind Maintenance:** Your blind can be dusted using a Renaissance Venetian Blind Duster. Your local Renaissance retailer can help you with this.

**NOTE:** These blinds are not advised for installation in conservatories or rooms where temperature may exceed 45°C